

Formline – Form Metrology

Unequivocal measurement of form and positional tolerances using innovative measuring systems. **SHARING EXCELLENCE**

# Your partner for measuring solutions

We deliver solutions that help you optimize your manufacturing process regarding qualitative and economic objectives.

Our services range from complete solutions for different measuring tasks such as the inspection of surface and form as well as determining dimensions, throughout every phase of the production process including final inspection or in the metrology lab.

We are one of the leading international specialists in high-precision, tactile and non-tactile production metrology.

Our decades of experience in tactile, optical and pneumatic measurement combined with our global sales and service support network brings us close to you, our customers, enabling us to provide optimal support as a reliable partner.

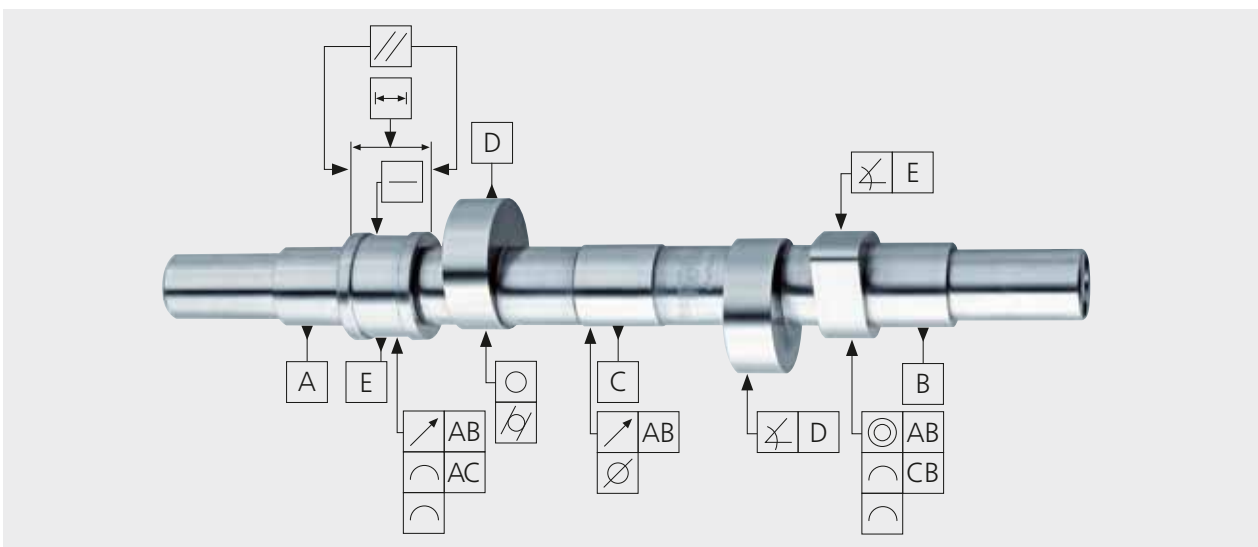
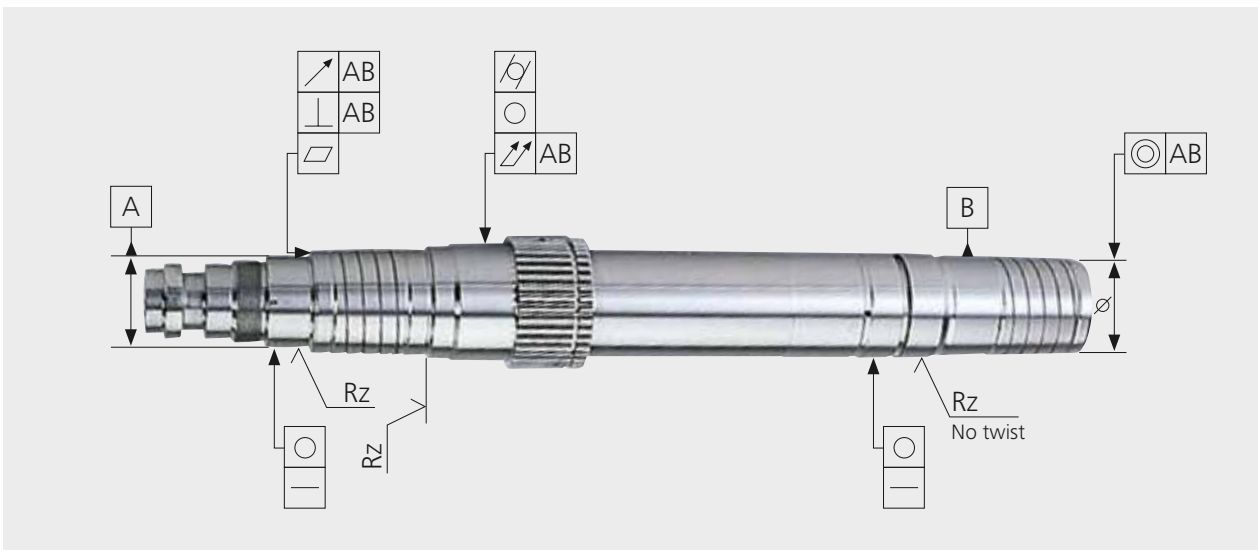

# Flexible and efficient form measurement

Measuring systems of our Formline series offer you extensive evaluation possibilities for shaft type and cubic workpieces.

## Form tolerances

- Straightness
- Roundness
- Flatness
- Cylindricity

## Position tolerances

- Parallelism
- Perpendicularity
- Angularity
- Coaxiality, concentricity

## Run-out tolerances

- Radial run-out
- Axial run-out
- Total radial run-out
- Total axial run-out

## Specific parameters

- Conicity
- Position deviation
- Length
- Stroke radius
- Crowning
- Angle deviation
- Waviness analysis
- Twist

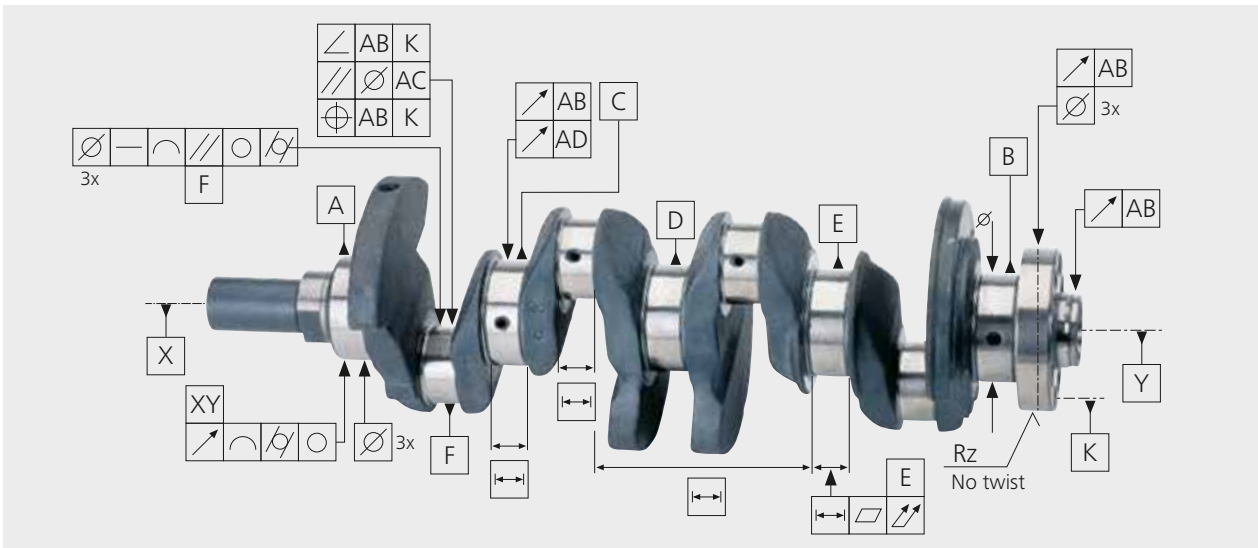



Form measuring systems with rotary table



Crank shaft and cam shaft measuring machines

## Get better measurements

### ... with versatility

The modular design of our Formline solutions guarantees the maximum flexibility for a wide range of applications. Our product line includes standard and custom CNC measuring systems for the determination of all form and positional tolerances as well as combined form and surface roughness measuring systems. You also get solutions for specific crank shaft and cam shaft measurements or form measurement in cylinder bores.

### ... with professional metrology

Formline solutions are the result of our decades of experience and extensive know-how in form metrology. They boast explicit measurements according to standards, easy operation and professional evaluation of the measured values.

### ... in day-to-day operations

Formline solutions measure with high accuracy in the measuring lab or in the shop floor. With a user-friendly evaluation software, they are easy to use and can be easily adapted to numerous measuring tasks thanks to an extensive range of accessories.

### ... with speed

Time is money. That's why we focus on automated measuring runs and Formline solutions, that offer optimized processes, adapted to the measuring tasks.

### ... with customized solutions

For your specific requirements, we develop measuring systems, that are adapted to your needs. You can rely on our experience in the development of customized solutions, for example for break disks, pistons, valves, conrods or injection parts.

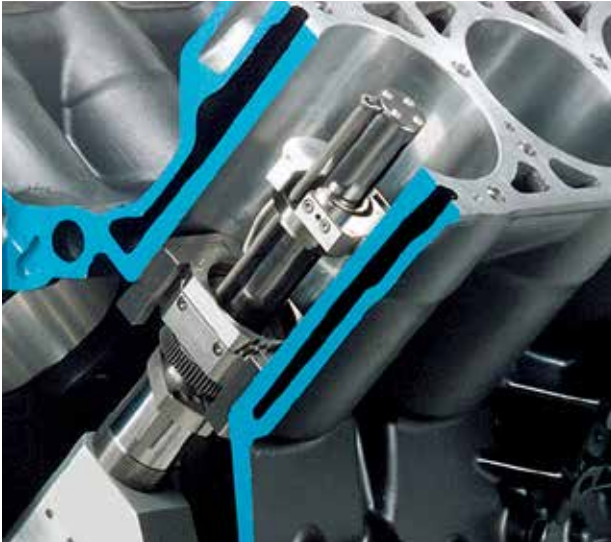

Measuring systems for cylinder bores

<b>Model</b>	<b>Brief description</b>	<b>Page</b>
F435 and F455	Fully automatic measurement of all form and positional tolerances, roughness and twist measurement as an option	6 – 7
Roundscan series	Combined form and roughness measuring systems with optional twist measurement	8 – 9
Turbo Form	Evaluation software for F435, F455 and Roundscan series	10 – 14
CFM3010	Measuring machine for crank shafts and cam shafts	19 – 20
Tolaris Shaft	Evaluation software for CFM3010	21 – 23
Incometer systems	Measuring systems for form and roundness in cylinder bores	24 – 27
Incowin	Evaluation software for Incometer systems	28 – 31

# Fully automatic measuring of all form and positional tolerances

The F435 and F455 form measurement systems allow you to determine roundness, cylinder form and flatness in a precise and reliable manner.

## Highlights Formline F435 and F455

- High degree of automation thanks to automatic centering and leveling of the workpiece and CNC controlled measuring axes
- Easy CNC programming and workpiece-specific measurement documentation
- Capable evaluation software for determination of all form and positional tolerances
- For demanding measuring tasks in series production or for frequently changing tasks in the metrology lab
- Optional roughness and waviness measurement with free probing system in Z-direction
- Optional twist measurement according to MBN 31007-07

## System features

- Highly accurate air bearing rotary table (Ø 250 mm) with automatic centering and leveling of the workpiece
- Three motorized measuring axes
- Vertical measuring axis with a measurement range of either 350 mm or 550 mm
- New generation of probes with magnetic coupling for fast probe arm changes
- Tilt arm FS1 for perfect probe positioning, even on complex workpieces
- Available as a desktop device or as an ergonomic measuring station with integrated air damping



Formline F435, ergonomic measuring station



Measurement of roughness and form with double-tipped probing system and magnetic coupling



Motorized tilt and rotation module MDS



Formline F435, desktop device with MDS

**Optional roughness and waviness measurement**

Thanks to the new FT1.1 probe generation and a double-tipped probing system, roughness and waviness measurements can be performed in addition to form measurements. And all this in a single clamping operation, saving you both time and money.

**Fully automatic measurements**

Thanks to the optional motorized tilt and rotation module MDS with its motorized axes for tilting (90°) and rotating

(270°), the probe is always positioned in the optimum probing position on the workpiece, thus allowing for the measuring of complex workpiece geometries without interrupting the CNC run.

**Compact desktop device**

Depending on requirements, the F435 and F455 measurement systems are available either as a compact desktop device or integrated into an ergonomic measuring station with damping.

Model	Workpiece weight	Distance C/Z axis	∅ measurable	Measuring height	Centering/leveling	Measuring axes	Option roughness
F435/F455 desktop	40 kg	325 mm	430 mm	350/550 mm	automatic	C, Z, R	no
F435/F455 station form	40 kg	325 mm	430 mm	350/550 mm	automatic	C, Z, R	no
F435/F455 station roughness	40 kg	325 mm	430 mm	350/550 mm	automatic	C, Z, R	yes, Z axis





# Highly efficient solution for combined form and roughness measurements

Depending on the measurement task, the combined form and roughness measurement systems from the Roundscan series can be configured to create the measurement situation that best suits your requirements.

## Highlights Formline Roundscan

- Time saving thanks to very fast, fully automatic centering and leveling and CNC controlled measuring axes for save measuring, even on complex workpieces
- Flexible use for combined form, roughness and twist measurements in a single clamping operation with no probe arm changes; small parts such as valves can be measured with a small measuring circle
- Ergonomically optimized design for convenient standing or sitting operation of the measuring system
- Highly accurate air bearing rotary table with impressive rigidity for consistently high precision

## System features

- High resolution with 0.1  $\mu\text{m}$  in the R/Z axis 0.1  $\mu\text{m}$  and 720.000 points in the C axis
- Integrated linear scale
- Air damping with active level control
- Vertical measuring axis available in three different heights, depending on requirements: 350, 550 or 900 mm
- Motorized tilt and rotation module for fully automatic measurements at measurement positions that are hard to access



Formline Roundscan 555 with optional printer container





MDS4 with double-tipped probing system FT3 with collision protection



Height-adjustable evaluation unit

**Fully automatic measurements with innovative probe system for efficient form, roughness or twist measurement**

- CNC controlled tilt and rotation module MDS4 for measurements at any position on the workpiece
- Double-tipped probing system for measurements with two different probe tips for form and roughness
- Adjustable and switchable probe force for measurements in accordance with standards
- Probing system can be switched from form to roughness during the CNC run
- High resolution of the axes for a minimal measuring point distance for roughness measurements
- Low measurement speed from 0.2 mm/s can be run
- Only very low basic interference of the measuring axes, even at maximum resolution

- Form and roughness measurements can be programmed fully automatically; no retooling times for fast and reproducible measurements
- Magnetic probe arm coupling for fast changing of the probe arm and protection in case of collisions

**Ergonomic measuring station**

- Height-adjustable, tiltable evaluation unit
- Convenient standing and sitting workstation
- Lockable cabinets for safe storage of evaluation computer and printer
- Control panel for performing key operations while maintaining a view of the workpiece and probe
- Integrated probe arm rest

Model	Workpiece weight	Distance C/Z axis	∅ measurable	Measuring height	Centering/leveling	Measuring axes	Option roughness
Roundscan 535	60 kg	370 (420*) mm	430 (530*) mm	350 mm	automatic	C, Z, R, X, Y	yes, C, Z, R axes
Roundscan 555	60 kg	370 (420*) mm	430 (530*) mm	550 mm	automatic	C, Z, R, X, Y	yes, C, Z, R axes
Roundscan 590	60 kg	370 (420*) mm	430 (530*) mm	900 mm	automatic	C, Z, R, X, Y	yes, C, Z, R axes

\* on request



# Software with clear user guidance for reliable measurement evaluation

The graphical, function-oriented Turbo Form user interface ensures simple operation, even when performing complex measurement tasks.

## Highlights Formline Turbo Form

- User-friendly interface with clear icons
- Simple definition of measurement positions and axis references
- Direct transfer of positions via teach-in
- Simple CNC programming using pictograms
- Fully automatic alignment and measurement of workpieces
- Comprehensive profile analysis and complete documentation of the measurement results

## System features

- For F435, F455 and Roundscan series
- Clear program flow
- Evaluation in accordance with standards
- Convenient test plan management
- User-defined presentation of measuring reports
- Numerous options for special applications
- Fast evaluation algorithms for prompt results
- CNC modules, Fourier analysis and 3D analyses included in the standard scope of delivery
- Automatic saving of PDF reports

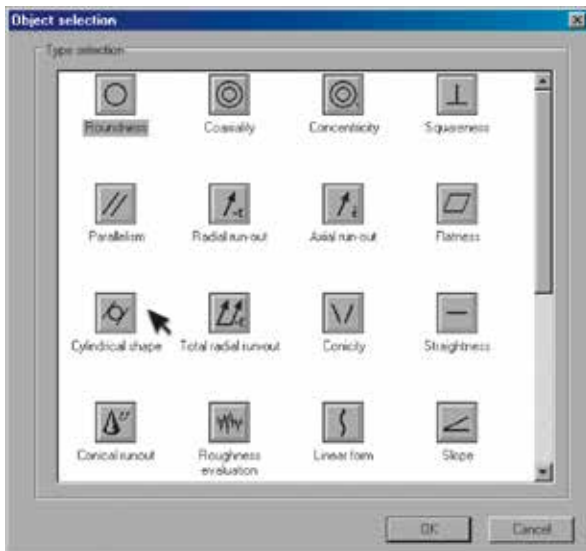

## Creating test plans

By clicking the mouse you select the required characteristic. The wizard guides you simply and safely through all the necessary steps.

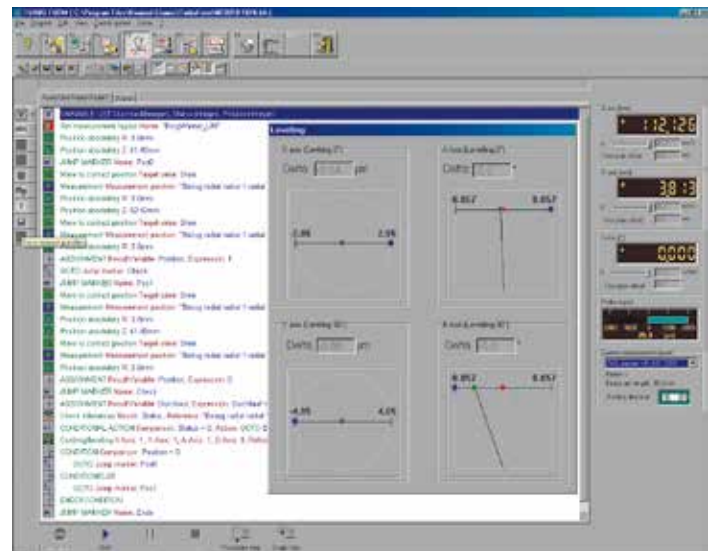

## Automatic alignment

Alignment is fully automatic and supported by the software to optimum effect.

**Automatic measurement runs: CNC**

A CNC run is quicker than a manual measurement sequence and provides user-independent, reproducible results. The aligned workpiece is automatically measured at the measuring positions defined in the test plan. Printing and saving of the reports can be integrated directly into the automatic run.

CNC programs are created by single steps in the teach-in mode and can then be changed step by step, either as a total measurement run or in single steps.

**Fourier analysis**

The measured profile is deconstructed into its spectral components and displayed as a graphic. Tolerance limits are defined with a limiting curve and a warning limit in order to detect recurring, high-frequency profile parts, such as chattermarks.

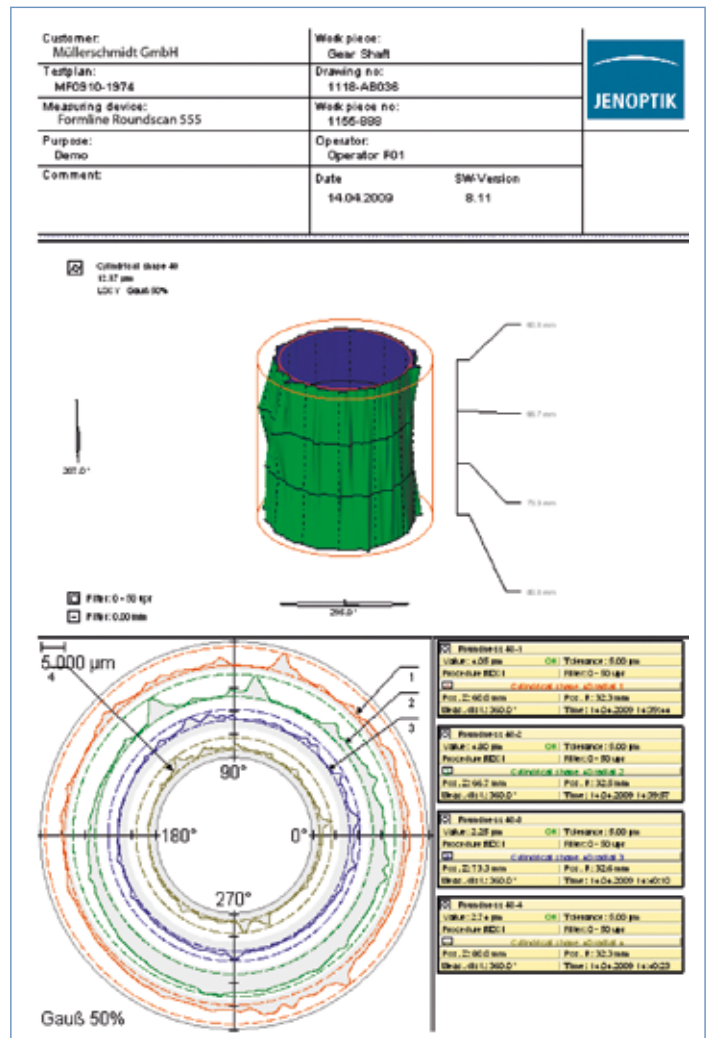
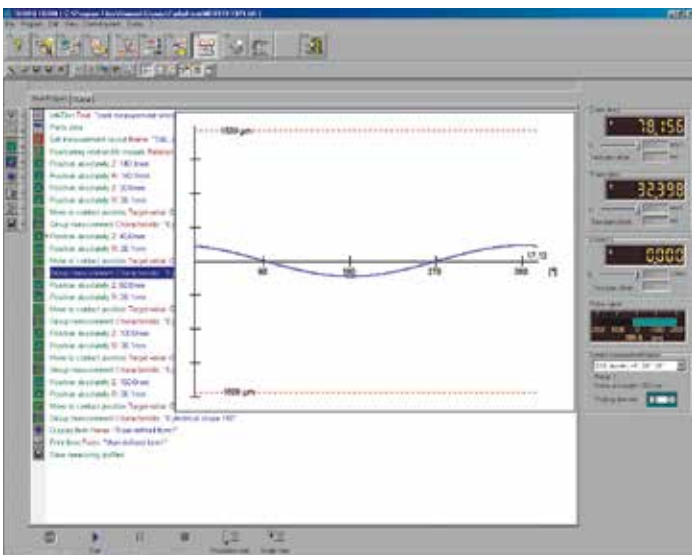

**Workpiece alignment and measuring run**

Depending on the device configuration, workpiece alignment and measuring run are performed automatically.

**Analysis and documentation**

After scanning the workpiece, the measuring profiles are displayed clearly and in accordance with standards in (3D) diagrams. Measurement data can also be exported via an optional interface.

# Software options for the evaluation of special measuring tasks

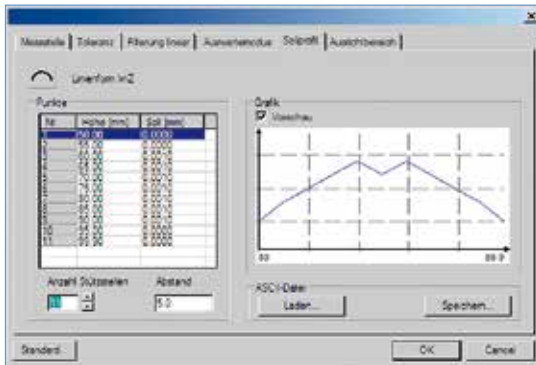

Line form

## Line form

Evaluation of the line form by a nominal curve with even tolerance band.

## Angular sector

Determination of the greatest roundness error within a defined angle segment.

## Fourier synthesis

Extraction of individual frequency ranges. Characteristics, which are then formed, no longer contain these waves.

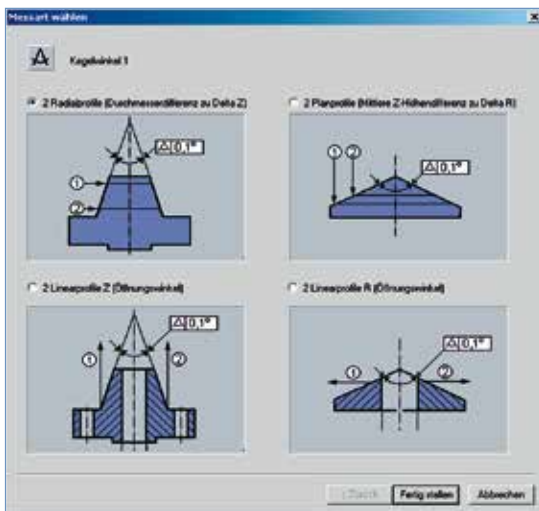

Cone

## Cone

Calculation of the cone angle from two polar or two linear profiles. Determination and clear 3D display of conical form and run.

## qs-STAT® interface

Certified according to AQDEF. Transfer of the measuring data to the statistics package qs-STAT® for process data analysis.

## ASCII export interface

Export of calculated characteristics and their measured values in ASCII format for further processing in other software programs such as Excel.

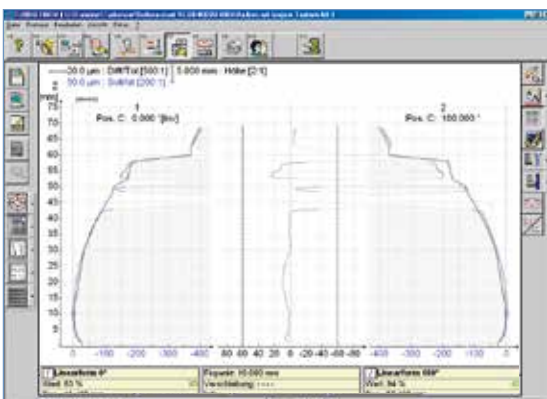

Linear form piston

## Piston measurement

Evaluation of typical characteristics on the outer surfaces of pistons and hub bores.

## Brake disk measurement

Evaluation of certain important properties of brake disks such as wobble, thickness difference, waviness and wear measurement.

## Dominant roundness waviness

Evaluation of the dominant roundness waviness in accordance with Daimler standard MBN 10455.

# Evaluation of roughness, waviness and profile

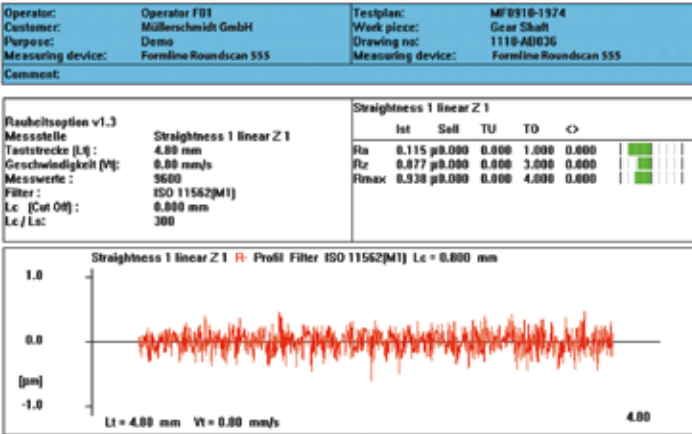

Roughness parameters and roughness profile



Measurement report

This optional module for F435 and F455, as well as the Roundscan series, enables fast, simple calculation, evaluation and graphical representation of all standard roughness, profile and waviness parameters in accordance with DIN/EN/ISO/JIS standards.

## Highlights option roughness measurement for Formline Turbo Form

- Various standard forms for evaluation
- Simple, clear configuration of measurement conditions
- Individual combination of parameters depending on the measurement task
- A wide range of display options simplifies profile analysis, e.g. superposition of several profiles, zoom, filter or fault extraction
- Free and individual design of screen and print forms
- Clear display of all form and roughness parameters in a characteristics table
- The key information is visible at a glance via the tolerance output and the status display

## Automatic roughness evaluation (CNC)

Roughness measurement positions are integrated into the CNC run by the appropriate program button. Measurement conditions such as probing force are adapted automatically. The results are displayed directly in the automatic measurement run and printed as required.

They can also be saved as a PDF file or exported via the ASCII or qs-STAT® interface (optional).



# Twist measurement according to MBN 31007-7

Twist refers to periodic structures which are comparable with the course of a thread. Magnified many times, it is visible as a micro-grinding structure. Twist structures at the sealing surfaces of shafts occur during grinding and impair the sealing function between the shaft and the sealing ring.

The most important properties of these structures can be determined with a 3D evaluation of the surface. The contact zone of the shaft is measured as a 3D area with a roughness stylus tip over a series of envelope line profiles. This allows a graphic representation of the twist structure as well as calculation of the twist parameters.

## Twist parameters

The F435, F455 and Roundscan systems support the current version of the MBN 31007-7 Daimler standard from 2009. This means that all parameters such as Number of threads DG, Twist depth Dt [ $\mu\text{m}$ ], Period length DP [mm], Feed cross section DF [ $\mu\text{m}^2$ ], Feed cross section per revolution DFu [ $\mu\text{m}^2/\text{r}$ ], Contact length in percent DLu [%] and Twist angle Dy [ $^\circ$ ] can be determined. Due to the optimized evaluation algorithms, the measurement results are much more stable. The reduction of the standard evaluation length from 5 mm to 2 mm reduces time considerably.

## TwistLive® analysis method

With this modern analysis method for all Roundscan systems, the normal measurement time may be reduced by 75 %. During the measuring progress, a results forecast of the twist parameters is already possible – live!



Twist measurement with a roughness stylus tip

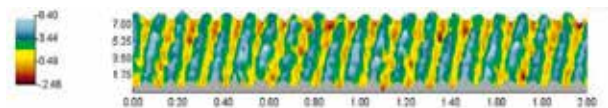

Display of unfiltered primary surface structure

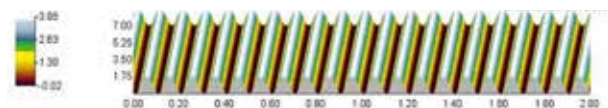

Display of twist structure in detailed scaling

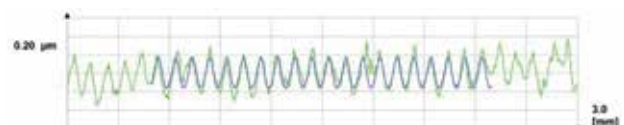

Display of original profile (green) and twist profile (blue)

# Accessories for F435, F455 and Roundscan series

We offer a wide range of standard and custom accessories for handling even the most complex workpieces.

## Chucks

With three, six or eight hardened clamping jaws for secure clamping of the workpieces on the rotary table.



**Chuck FX70**  
Chuck range  
Internal 18–62 mm  
External 2–68 mm  
Art. 232 036



**Chuck FX100**  
Chuck range  
Internal 28–95 mm  
External 2–95 mm  
Art. 232 357



**Chuck FX150**  
For 250 mm rotary table  
Chuck range  
Internal 46–140 mm  
External 2–140 mm  
Art. 232 359



**Chuck FX150**  
For 150 mm rotary table  
Chuck range  
Internal 46–140 mm  
External 2–140 mm  
Art. 507 001

## Motorized tilt and rotation module MDS for F435 and F455

With this module the probe is always positioned in the optimum probing position on the workpiece. Thus complex workpiece geometries can also be measured fully automatically.  
Art. 1006 0796



## Instrument tables for F435 and F455

### For desktop devices

GTS with drawers	Art. 232 900
GTS-K	Art. 232 901

### Measuring stations with integrated damping

GTF-3 with spring elements	Art. 1006 3184
GTF-3 with air damping	Art. 1006 3185





# Probe arm set for individual measuring tasks



## Probe arm set FTM for F435, F455 and Roundscan series

With the FTM probe arm set you cover the most frequent form measuring tasks. Its components may also be ordered separately.

Probe arm set FTM

Art. 1002 9224

## Components included in the probe arm set FTM:

Probe tip M2 pin wrench

Art. IM05 1215

Hexagonal key wrench

Art. IM02 6349

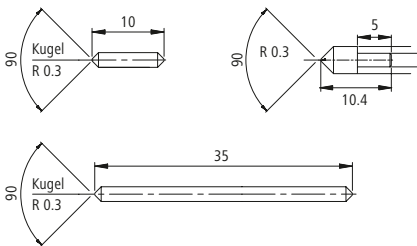

## Probe tip FO KE300/90H L10 D2/10

L = 10 mm, 2x carbide tips 300  $\mu$ m/90°

Art. 519 520

## Probe tip FO KE300/90H L10.4 D4-2/5.4-5

L = 10.4 mm, 2x carbide tips 300  $\mu$ m/90°

Art. 243 519

## Probe tip FO KE300/90H L35 D2/35

L = 35 mm, 2x carbide tips 300  $\mu$ m/90°

Art. 241 712

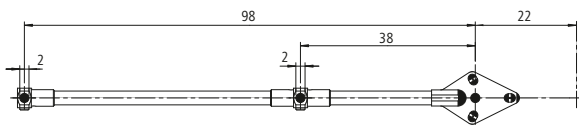

## Probe arm FTM-HR-L038\*098-D2\*D2

The probe tip at 38 mm is suitable for outside measurements; the probe tip at 98 mm is used for measurements in bores.

2x probe tip supports  $\varnothing$  2 mm, L1 = 38 mm, L2 = 98 mm

Art. 1003 0456

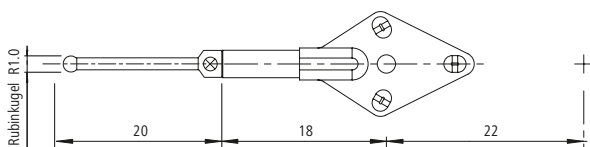

## Probe tip M2 KU1000/-R L20 D1.0/14.0

L = 20 mm, 1x ruby ball 1000  $\mu$ m,

1x M2 thread

Art. IM05 1207

## Probe arm FTM-HA-L018-M2

L = 18 mm, axial probe tip, 1x M2 thread,

without probe tip

Art. 1000 3942

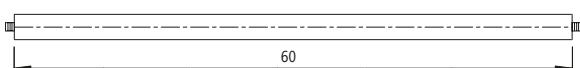

## Probe tip extension M2V L60 KE D3.0/60.0

L = 60 mm, 1x M2 thread

Art. 1003 4259

# Probe arms for various applications

## Standard probe arm and probe tip

To cover the most frequent measurement tasks. Included in the scope of delivery of the form measuring systems F435, F455 and all Roundscan models.

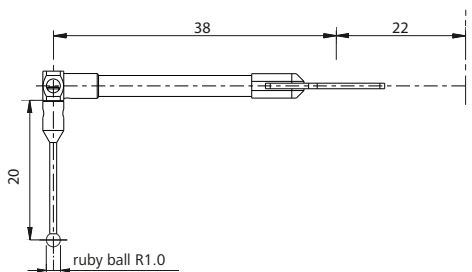

### Probe arm FTM-R-L038-KU1.0-R

L probe arm = 38 mm, L probe tip = 20 mm,  
radial probe tip, 1x ruby ball 1000  $\mu\text{m}$

Art. 1006 5094

## Special probe arms for measurements in small bores from 3 mm

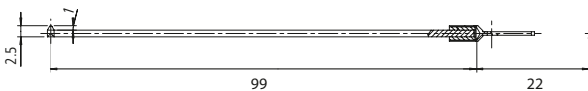

### Probe arm FTM-R-L099-KE0.3-60H

For form measurement. L = 99 mm, radial probe tip,  
1x carbide tip 300  $\mu\text{m}/60^\circ$

Art. 1001 1703

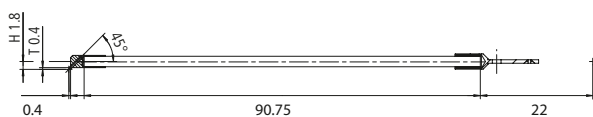

### Probe arm FTM-R-L098-KE5/-60D

For roughness measurement. L = 98 mm,  
radial probe tip, 1x diamond tip 5  $\mu\text{m}/60^\circ$ ,

45° probe tip mounting

Art. 1004 0375

90° probe tip mounting

Art. 1004 0389

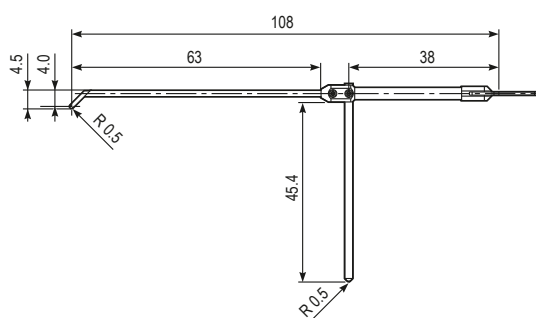

### Probe arm FTM-HR-L038\*108-KE0.5-90H-KU0.5H

For measurements on end faces, in bores and on the  
bottom surfaces of bores. L1 = 38 mm, 1x carbide tip  
500  $\mu\text{m}/90^\circ$ ; L2 = 108 mm, 1x carbide tip 500  $\mu\text{m}$

Art. 1005 2509

### Probe tip FO KE500/90H L50 D2/50

L = 50 mm,

1x carbide tip 500  $\mu\text{m}/90^\circ$

Art. 1005 2561

# Probe arms and probe tips with thread

For form measuring systems F435, F455 and all Roundscan models

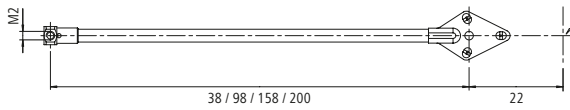

- Probe arm FTM-HR-L038-M2  
L = 38 mm, 1x radial M2 thread      Art. 1000 3938
- Probe arm FTM-HR-L098-M2  
L = 98 mm, 1x radial M2 thread      Art. 1000 9711
- Probe arm FTM-HR-L158-M2  
L = 158 mm, 1x radial M2 thread    Art. 1000 9714
- Probe arm FTM-HR-L0200-M2  
L = 200 mm, 1x radial M2 thread    Art. 1003 8257

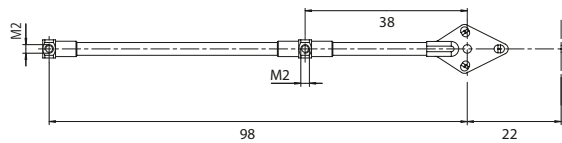

- Probe arm FTM-HR-L038\*098-M2\*M2  
L1 = 38 mm, 1x radial M2 thread,  
L2 = 98 mm, 1x radial M2 thread    Art. 1002 4596

## Probe tips M2 with ruby ball

Standard probe tips for precise form measurement.

### Probe tip M2 KU1000/R L10 D1.0/4.0

L = 10 mm; 1x ruby ball 1000 µm,  
1x M2 thread      Art. IM05 1208

### Probe tip M2 KU1000/R L15 D1.0/4.0

L = 15 mm, 1x ruby ball 1000 µm,  
1x M2 thread      Art. 1002 9794

### Probe tip M2 KU1000/R L20 D1.0/4.0

L = 20 mm, 1x ruby ball 1000 µm,  
1x M2 thread      Art. IM05 1207

## Probe tips M2 with diamond tip

For the exact determination of the surface parameters.

### Probe tip M2 KE5 / 90GD L5 D3 M2

L = 5 mm, 1x diamond tip 5 µm/90°,  
1x M2 thread      Art. 1002 9793

### Probe tip M2 KE5 / 90GD L15 D3 M2

L = 15 mm, 1x diamond tip 5 µm/90°,  
1x M2 thread      Art. 1002 5091

## Probe tips M2 with cone tip

For measurements on ground and lightly soiled measuring points.

### Probe tip M2 KE300/90H L5 D3/M2

L = 5 mm, 1x carbide tip 300 µm/90°,  
1x M2 thread      Art. 1004 4157

### Probe tip M2 KE300/90H L10 D3/M2

L = 10 mm, 1x carbide tip 300 µm/90°,  
1x M2 thread      Art. 1004 4188

### Probe tip M2 KE300/90H L15 D3/M2

L = 15 mm, 1x carbide tip 300 µm/90°,  
1x M2 thread      Art. 1004 4189

# Comprehensive competence for crank shafts, gear shafts and cam shafts

Measure your crank shafts and cam shafts quickly and accurately with the fully automatic, CNC controlled CFM3010 measuring machine.

## Highlights Formline CFM3010

- Secure measurement results, as there are no mechanical transverse forces
- Excellent basic accuracy thanks to high-resolution measurement systems
- Robust construction with vibration decoupling for use in the measuring room or in the laboratory
- Optimized CNC runs in conjunction with high measurement and travel speeds
- Can be used flexibly for a variety of workpieces

## System features

- Gaging component capability: measuring accuracy with repeatability of up to 0.3  $\mu\text{m}$
- Distance between tips: 1250 or 1500 mm
- Fast measurement value recording
- Wear-free air bearing measuring slides
- Capable evaluation software Tolaris Shaft for cam shafts and crank shafts



Formline CFM3010

Model	Workpiece weight	Test diameter	Measuring height
CFM3010	150 kg	300 mm	1250 or 1500 mm



# Accessories for crank shaft and cam shaft measurements

We offer a wide range of standard and custom accessories for easy handling of the workpiece. Thanks to the cam shaft standard, traceable cam form deviation measurements can be performed.

## Measuring drivers and followers for different measuring tasks and workpieces



Universal driver



Workpiece-specific axial driver



Workpiece-specific radial driver



Flat measuring follower for crank shafts and convex cam shafts



Round measuring follower made of different materials and diameters for cam shafts



Nockenwellennormal

## Cam shaft standard for traceable measurements

- PTB\* certified evaluation software Tolaris Shaft for cam shafts
- DAkS-DKD calibrated cam shaft standard
- Practice-oriented, reliable, traceable and therefore comparable status reports and status evaluations of cam shaft measurement systems
- Comparability of evaluation strategies and detached consideration of the influence of the software from a purely mechanical measurement process
- Definition of measuring uncertainty on the basis of synthetic reference information
- Certified measuring uncertainty of the software  $\leq \pm 0.1 \mu\text{m}$  (cam form) or  $\pm 0.1''$  (angle)
- Evidence of gaging machine capability ( $C_g$ ,  $C_{gk}$ )
- Evaluation of form and dimensional deviations in all the main characteristics

\* Federal Physical-Technical Institute – Physikalisch-Technische Bundesanstalt (PTB)

## Characteristics measured

- Cam form & pitch
- Cam height & width
- Cam base circle radius & run-out
- Cam angle position
- Diameter
- Circularity
- Straightness
- Parallelism
- Cylindricity

# Modern evaluation software for reliable process control

The Tolaris Shaft evaluation software for the CFM3010 crank shaft and cam shaft measuring machine is easy to use and takes all key aspects for controlling and optimizing modern production processes for crank shafts and cam shafts into account.

## Highlights Formline Tolaris Shaft

- Optimized for the measurement and evaluation of crank shafts and cam shafts
- Intuitive dialogs to support recurring tasks
- Standardized displays to make it easy to familiarize yourself with the software and use it reliably
- Extensive toleration functions
- Clear profile graphics
- Simple print form creation
- Control charts
- Extensive data exports to correct machine tools

## System features

- Characteristic-oriented programming
- Offline programming
- Scope for expansion to include specific evaluation functions
- Measuring process management
- Accessories management
- User management
- Windows-compliant operation

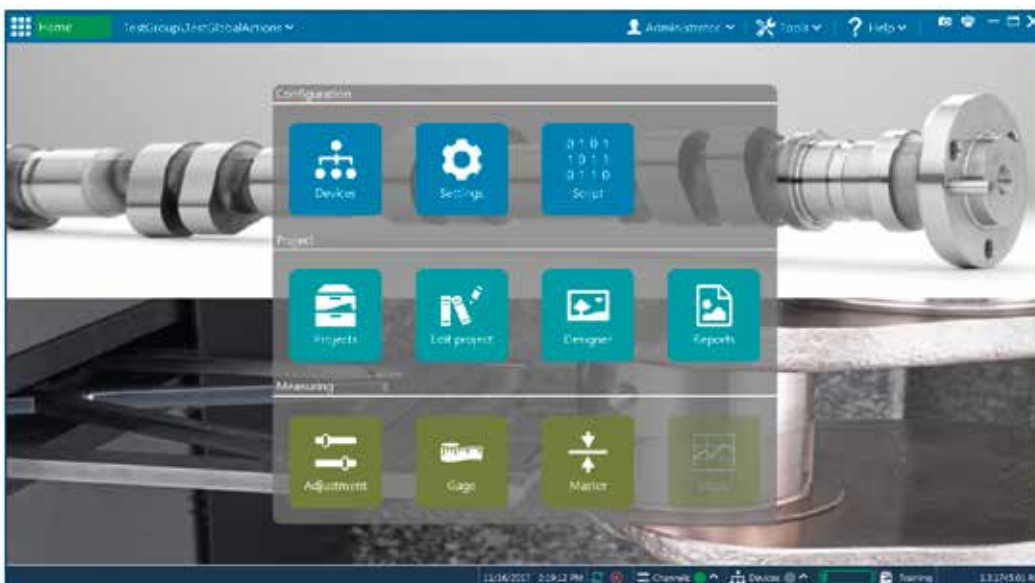

Start screen with easy-to-understand icons

# Evaluation of special measurement tasks

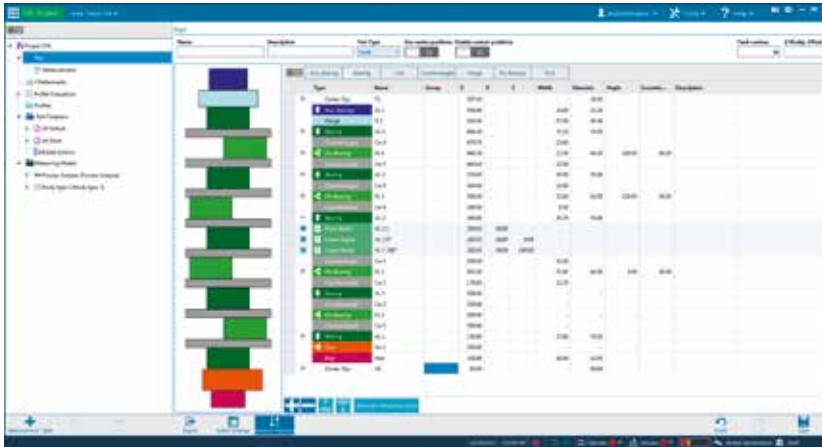

**Characteristic-oriented programming**  
The workpiece is displayed in schematic format together with details of the measuring positions, making it easier to program the characteristics to be measured.

The required test characteristics are selected from an extensive library of measuring characteristics and provided with the relevant references.

Workpiece displays together with characteristics



## Machine control and CNC programming

The axis control functions for the machine are clearly arranged in a single view.

- Quick positioning to a specific measurement position for carrying out a single measurement
- Positioning sequences are programmed to create CNC programs

Axis control

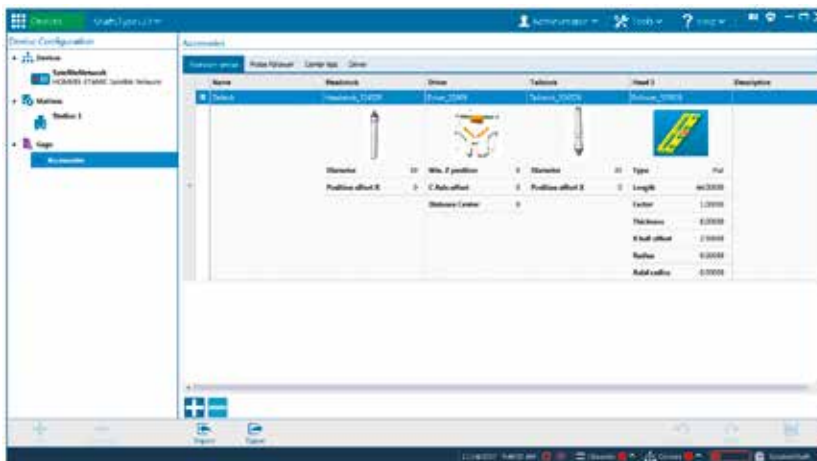

## Accessories Management

The accessories management feature makes it easier to organize the clamping equipment and measuring elements required for specific workpieces.

The technical data of the accessory in use is taken into account by the measuring programs. When a clamping device is replaced, the corresponding measuring programs do not need to be changed.

Management of workpiece-specific accessories



## Meaningful profile graphics

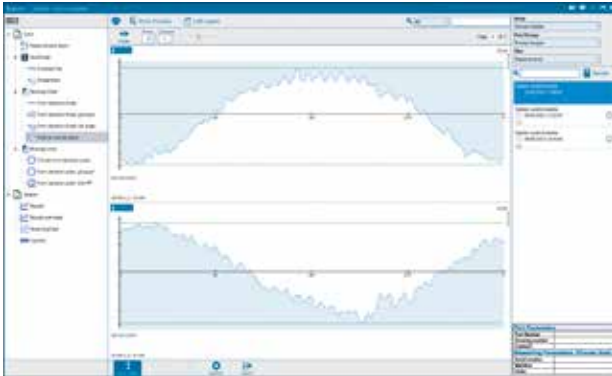

Axial run-out

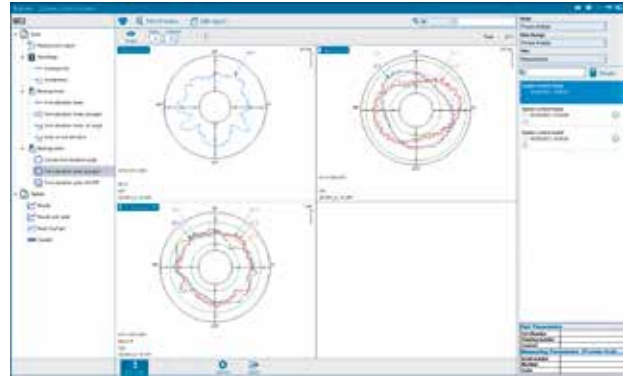

Form deviation on bearings

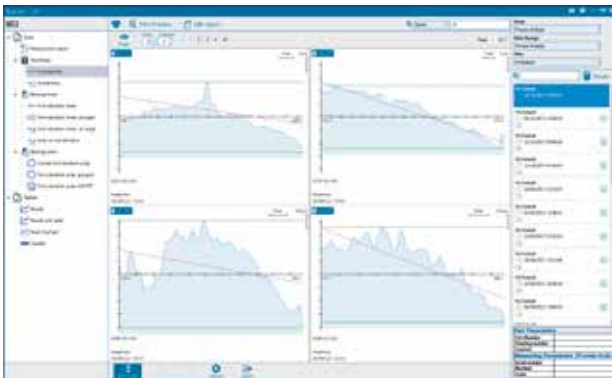

Envelope lines



Overview of results

# Software options for Tolaris Shaft

## qs-STAT® export

Certified in accordance with AQDEF. Process data is transmitted to the qs-STAT® statistics package for analysis.

## Chatter marks

Fourier analysis of the surface waviness. Evaluation of the amplitude values of the harmonic waves with toleration above the limit curve.

## Roundness waviness

For measuring and evaluating the dominant roundness waviness in accordance with Daimler standard MBN 10455.

## Cam form

Evaluation of specific characteristics when measuring cam forms.

- Base circle diameter/base circle difference
- Cam height
- Form deviation of cam form (pre-cam, main cam, post-cam)
- Form deviation differences
- Form growth
- Cam angle to reference element

## Classification

The classification by tolerance classes allows the characteristics measured to be broken down according to the specified quality grades.



Formline Incometer V

## Flexible measuring systems for form and roundness in cylinder bores

The Incometer V measuring systems offer fast, reliable and highly accurate measurements for analytic examination of cylinder-piston configurations in engine block development.

### Highlights Formline Incometer V

- Flexible and mobile use during development and testing
- Resistant to vibrations, making it ideal for measurements during production
- Easily adapted to different cylinder dimensions thanks to the clamping mechanism
- The probe's self-adjustment eliminates time-consuming alignments
- Automatic correction of any eccentricities or inclined positions of the cylinder axes to the measuring probe via the software
- Shortest measuring times on the market

### System features

- Measurement of cylinder distortion and wear, also under temperature influences
- Assistance for the dimensioning of piston rings
- Measurement with mounted cylinder head possible
- Compact, robust measuring probe
- Scanning measuring method
- Simple operation via Windows software with pre-defined measuring routines
- By changing measuring tips and clamping jaws, the probe easily adjusts to different diameters

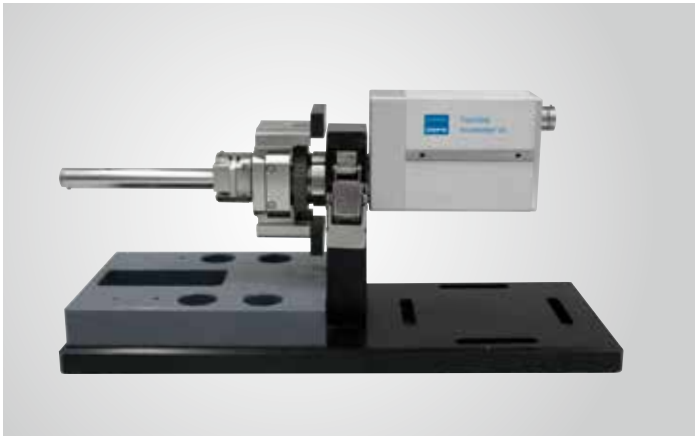

Formline Incometer VS

**Measuring cylinder distortions**

- Measurement and evaluation of the influence of cylinder heads and gaskets on bore distortion
- Thanks to its extremely compact design, the Incometer probe can be installed on the crank shaft side in order to measure inside cylinder bores with the cylinder head mounted
- In the case of long-term testing, wear rates and cylinder distortion can also be monitored

**Temperature distortion**

- Simple fixturing and high speed allow for measurement of engine blocks, even under high temperature conditions
- Distortion-specific analysis of the critical warm-up phase with extreme differences in temperature between the cylinder head and the engine block

**Incometer VS for small engines**

Analysis of cylinder distortions in small motors, e.g. for:

- Motorcycles
- Agricultural and forestry equipment
- Compressors of cooling systems

**Incometer V110 for flat engines**

Analytical testing of the cylinder-piston configuration in engines with particularly difficult installation requirements, e.g. extremely flat V engines.



Formline Incometer V110

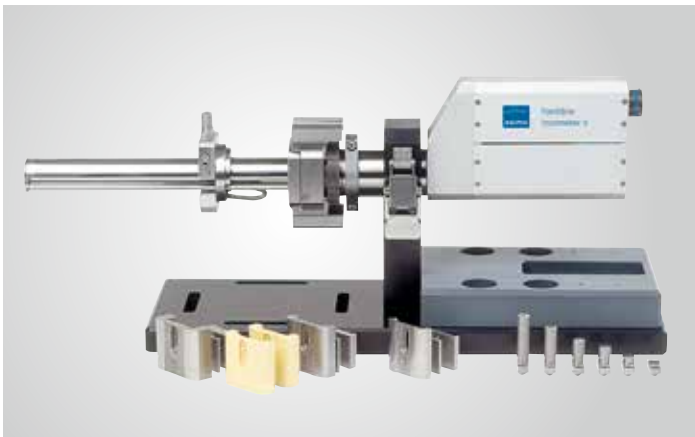

Mounting device and accessories for Incometer V



External plate for fixing the probe

Model	Test diameter	Axial measuring range	Radial measuring range
Incometer V	65 – 155 mm	80 – 200 mm (depending on model)	±400 µm
Incometer V110	65 – 155 mm	110 mm	±400 µm
Incometer VS120	39 – 100 mm	120 mm	±500 µm



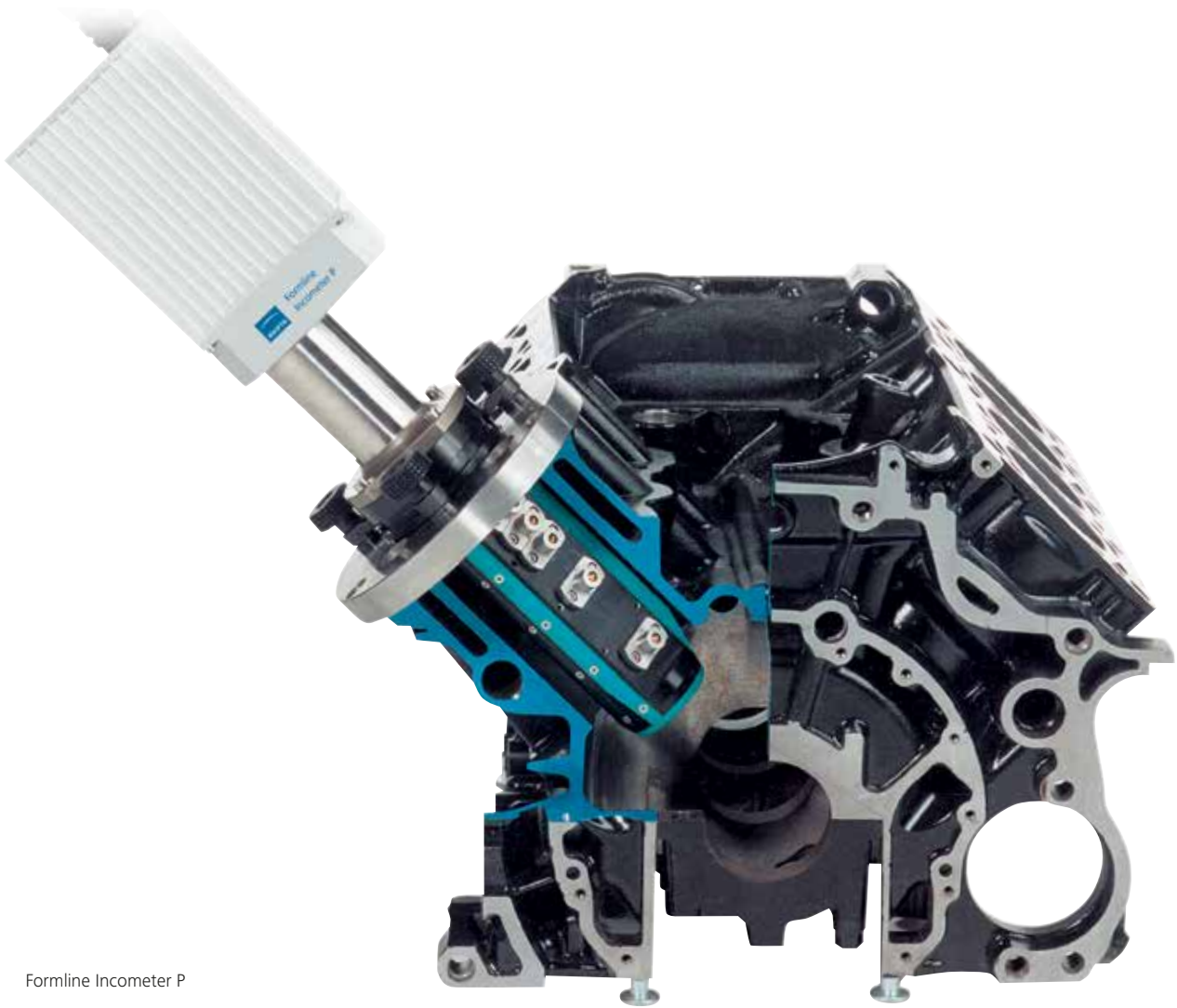

Formline Incometer P

## Fast form measurement in cylinder bores

The Incometer P delivers fast, reliable and highly accurate quality data during production.

### Highlights Formline Incometer P

- Fast measurement readiness, as no manual alignment is required
- Measurement of the cylinder bore in just a few seconds
- Fast adaptation to different bore diameters thanks to interchangeable measuring tips
- Ideally suited for flexible production lines
- Simple operation, even without previous experience

### System features

- Compact and robust design for mobile use during production
- Minimization of disruptive vibrations thanks to direct mechanical connection between the measuring probe and the workpiece
- Automatic correction of inclinations and eccentricities by the software
- Precision measurements of roundness and form in seconds during engine production



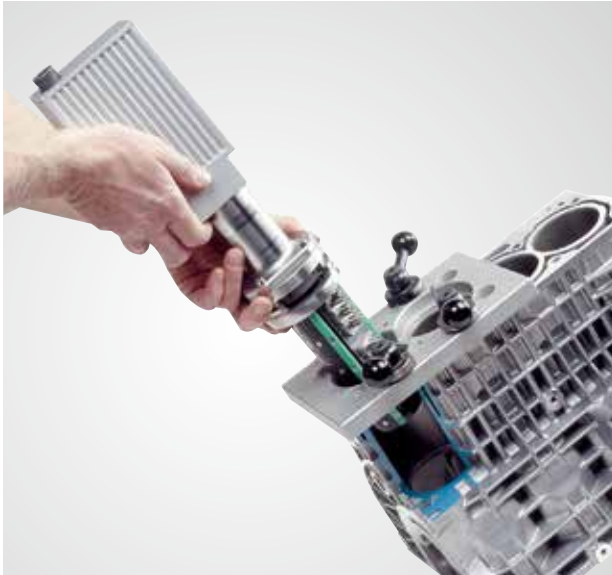

Inserting of the probe

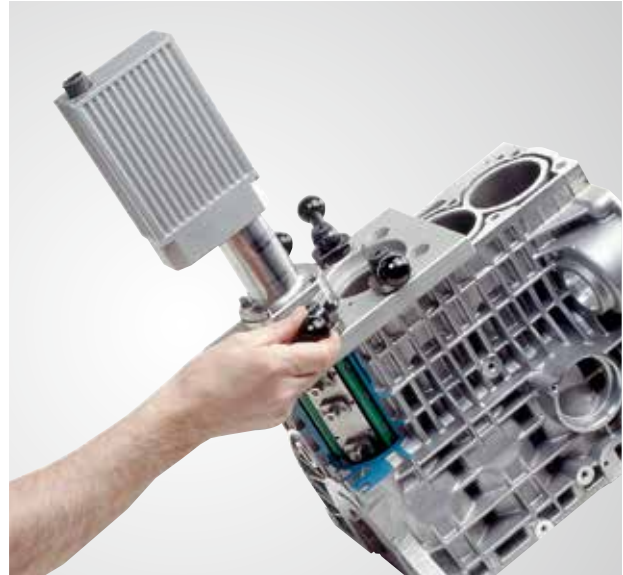

Fixing of the probe

**Easy handling and fast measurement**

Measuring a cylinder bore with the Incometer P takes only a few seconds:

- Insertion of the probe into the cylinder
- Plastic guide rails protect the cylinder wall
- Adjustment of the probe to the bore via a fixture plate

- Simply attaching the clamping levers connects the Incometer P to the engine block
- Start of the measurement and 360° rotation of the measuring head
- Scanning, dynamic recording of the measurement values of all previously positioned sensors at a constant speed
- Measurement values are available immediately
- Choice of up to 7 sensors per measuring head

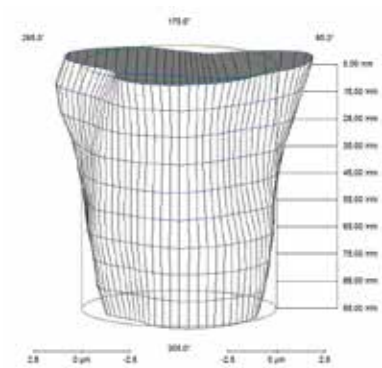

Isometric plot of a cylinder

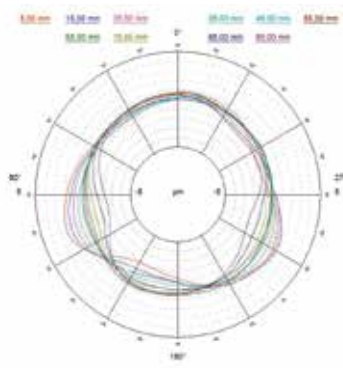

Radial plot of a cylinder bore measurement

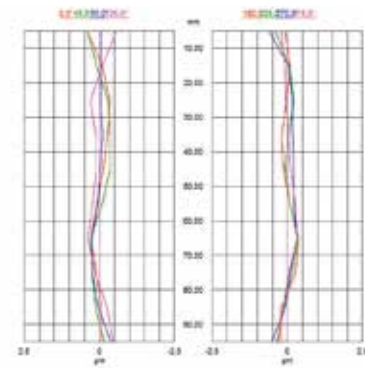

Axial plot of a cylinder bore

Model	Test diameter	Axial measuring range	Radial measuring range
Incometer P100	60 – 110 mm	max. 300 mm	±500/1000 µm (depending on the diameter)



# Clearly structured evaluation and control software

The clearly structured Incowin software ensures that operating the measuring systems is easy, even with no previous experience. Once the measurements have been taken, all procedures, such as saving and printing the measurement results and statistically evaluating them, can be performed automatically.

## Highlights Formline Incowin

- Rapid set-up of all user-specific requirements
- Multiple display options for easy analysis of the measurement results
- Easy creation of new measuring programs
- Customization of screen and print forms
- Template language selectable independent from user language

## System features

- Optimal mobility with a notebook
- Clear and easy-to-understand user interface for intuitive operation
- Central data backup possible via network operation
- Extensive range of options for engine development and production

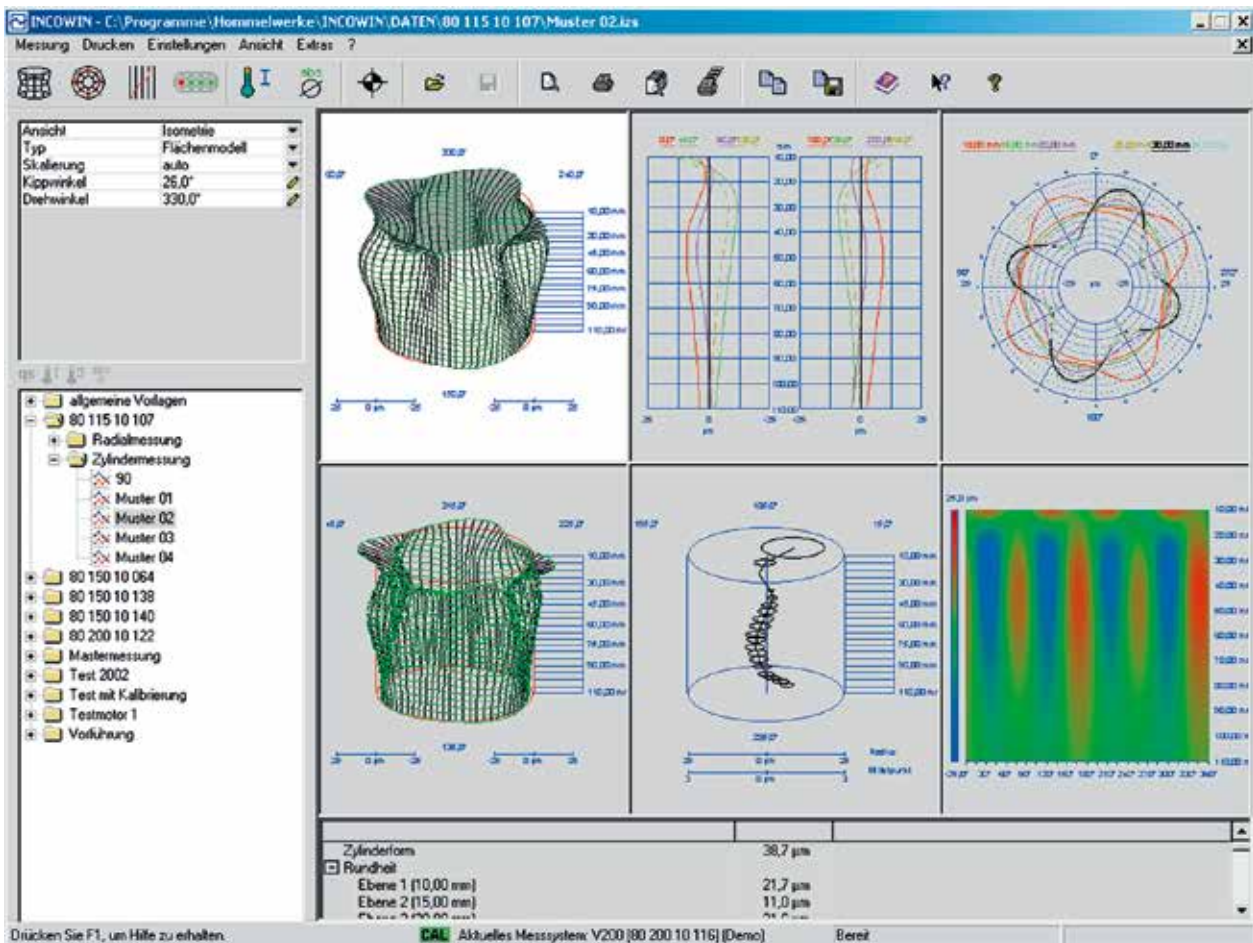

Clearly arranged desktop







# Software options for production

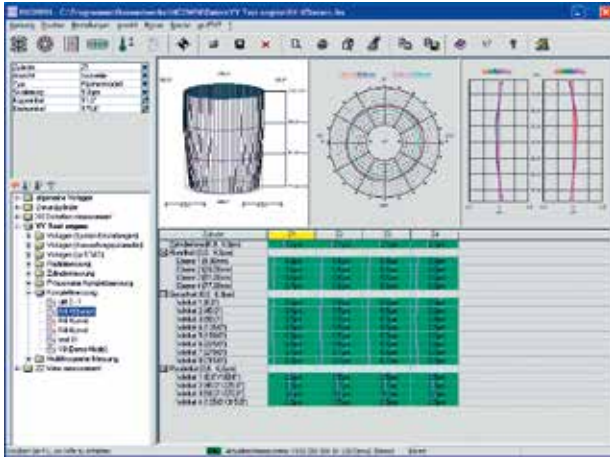

Block measurement

## Block measurement and complete evaluation

For measuring a complete crankcase with one-time input of the reference data. The user is guided through the entire measuring procedure via diagrams. All cylinder measurements of a crankcase are saved in a single file. The evaluation contains the printout of the form parameters for all cylinders in a table and provides a graphic display of the radial and axial measurement and the isometries for all cylinders on one page.

## Data transfer to qs-STAT®

The qs-STAT® interface certified by Q-DAS allows the measurement results to be transferred to a statistics package for further process data analysis.



qs-STAT® interface

## Determining the absolute diameter

For determining the absolute diameter of the cylinder of a crankcase. To this end, the Incometer is calibrated to the nominal dimension of the cylinder diameter before each measurement.

## Advanced user administration

For creating different users and user groups with their own profiles. The individual users can each be assigned to a specific group and given a personal password.

## Automatic functions

For automating processes, such as saving, printing etc. in order to reduce errors resulting from incorrect inputs or user mistakes.

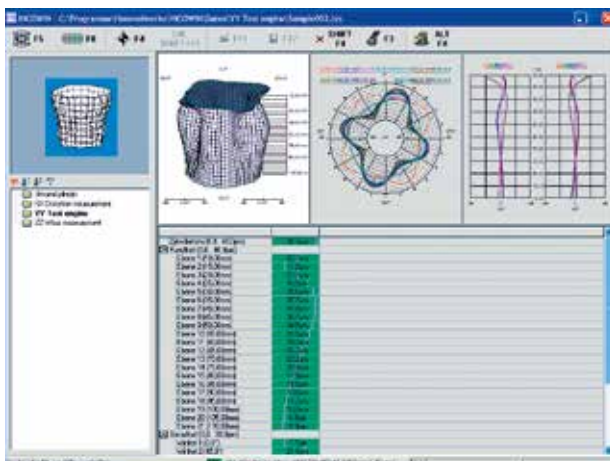

User administration

# Technical data

## Formline F435, F455 and Roundscan series

Model	F435   F455	Roundscan 535   555   590
<b>Measuring range</b>		
Distance C/Z axis. max. interfering edge radius	325 mm	370 (420) <sup>1)</sup> mm
Max. test diameter	430 mm	430 (530) <sup>1)</sup> mm
Max. measuring height	350   550 mm	350   550   900 mm
<b>Rotation axis (C axis)</b>		
Table diameter	250 mm	330 mm
Workpiece alignment	automatic	automatic
Roundness error $\mu\text{m}+\mu\text{m}/\text{mm}$ measuring height	0.02+0.0005 $\mu\text{m}$	0.02+0.0005 $\mu\text{m}$
Roundness error $\mu\text{m}+\mu\text{m}/\text{mm}$ measuring height <sup>2)</sup>	0.01+0.00025 $\mu\text{m}$	0.01+0.00025 $\mu\text{m}$
Axial run-out error $\mu\text{m}+\mu\text{m}/\text{mm}$ radius	0.03+0.0005 $\mu\text{m}$	0.03+0.0005 $\mu\text{m}$
Axial run-out error $\mu\text{m}+\mu\text{m}/\text{mm}$ radius <sup>2)</sup>	0.015+0.00025 $\mu\text{m}$	0.015+0.00025 $\mu\text{m}$
Centering range	$\pm 2$ mm	$\pm 5$ mm
Leveling range	$\pm 0.6^\circ$	$\pm 1^\circ$
Measuring and positioning speed	1 – 12 1/min.	0.2 – 30 1/min.
Bearing	air	air
Max. charge	400 N	600 (1000) <sup>1)</sup> N
<b>Vertical axis (Z axis)</b>		
Measuring distance	350   550 mm	350   550   900 mm
Straightness error/100 mm	0.15 $\mu\text{m}$	0.15   0.15   0.25 $\mu\text{m}$
Straightness error/measuring distance	0.3   0.4 $\mu\text{m}$	0.3   0.45   1.5 $\mu\text{m}$
Parallel C-Z/measuring distance	0.8   1.3 $\mu\text{m}$	0.5   0.8   2.5 $\mu\text{m}$
Measuring and positioning speed	0.2 – 23 mm/s	0.2 – 50 mm/s
Collision protection	yes	yes
<b>Horizontal axis (R axis)</b>		
Measuring distance	220 mm	220 mm
Straightness error/100 mm	0.3 $\mu\text{m}$	0.25 $\mu\text{m}$
Straightness error/measuring distance	0.6 $\mu\text{m}$	0.5 $\mu\text{m}$
Squareness C-R	1.2 $\mu\text{m}$	0.8 $\mu\text{m}$
Measuring and positioning speed	0.2 – 14 mm/s	0.2 – 50 mm/s
<b>Dimensions/weight</b>		
Length	790 (1010) <sup>3)</sup> mm	1990 mm
Width	510 (650) <sup>4)</sup> mm	750 mm
Height	960   1160 mm	1760   1960   2310 mm
Weight (approx.)	290   300 kg	650   665   685 kg

All accuracy data according to EN ISO 1101 at 20°C  $\pm 1^\circ\text{C}$  in vibration neutral environment.  
Filter 0–15 rpm LSCI, or 2.5 mm LSLI; 6 rpm, or 4 mm/s.  
All proof on standard under inclusion of the compensation method.

- <sup>1)</sup> On request
- <sup>2)</sup> Values as maximum deviation from the reference circle LSCI, filter 0-15 rpm LSC, 6 rpm
- <sup>3)</sup> R axis extended
- <sup>4)</sup> With servo box

## Formline CFM3010

Model	CFM3010
<b>Measuring range</b>	
Distance C/Z axis. interfering edge radius <sup>2)</sup>	162 mm
Max. test diameter	300 mm
Max. measuring height	1250 (1500) mm
Max. traverse distance radial	210 mm
<b>Rotation axis (C axis)</b>	
Face plate	196 mm
Workpiece alignment	tips
Measuring speed	2 – 40 1/min.
Bearing	mechanical
Max. charge	1500 N
Traversing speed	2 – 40 1/min.
Resolution	0.00005°
Positioning accuracy	0.1°
Accuracy	$\pm 0.00028$
Run-out accuracy of the roller bearing	0.25 $\mu\text{m}$
<b>Vertical axis (Z axis)</b>	
Travel distance	1290 (1590) <sup>1)</sup> mm
Measuring distance	1250 (1500) <sup>1)</sup> mm
Collision protection	yes
Positioning speed	5 – 150 mm/s
Positioning error/measuring distance	0.05 mm
Measuring and positioning speed	5 – 150 mm/s
Resolution of the Z scale	0.1 $\mu\text{m}$
Accuracy	$\pm 3$ $\mu\text{m}$
<b>Straightness axis (X axis)</b>	
Measuring distance	210 mm
Resolution	0.02 $\mu\text{m}$
Accuracy	$\pm 0.2$ $\mu\text{m}$
Setting range of measurement force	1, 2, 3 and 4 N
<b>Travel in X direction</b>	
Measuring point distance	0.1/0.2/0.5/1
Resolution radial	0.02 $\mu\text{m}$
Resolution axial	0.1 $\mu\text{m}$
<b>Dimensions/weight</b>	
Length	1240 mm
Width	1360 mm
Height	2450 mm
Weight (approx.)	2400 kg

- <sup>1)</sup> On request
- <sup>2)</sup> Standard flat measuring follower, length 43 mm

# Technical data

## Formline Incometer systems

Model	Incometer V					Incometer VS	Incometer P
	V80	V115	V150	V200	V110	VS120	P100
Diameter of the cylinder <sup>1)</sup>	65 – 155 mm					39 – 100 mm	60 – 110 mm
Clamping length min.	20 mm	20 mm	25 mm	30 mm	40 mm	ext. fixture	ext. fixture
Axial measuring range	80 mm	115 mm	150 mm	200 mm	110 mm	120 mm	max. 300 mm
Measuring path on the circumference	360°					360°	360°
Radial measuring range <sup>3)</sup>	± 400 µm					± 500 µm	± 500/1000 µm <sup>3)</sup>
Resolution	0.1 µm					0.1 µm	0.1 µm
Number of measured values per rotation	14,400/1,024					14,400/1,024	14,400/1,024
Number of sensors	1					1	max. 7
<b>Repeating accuracy</b>							
Roundness	≤ 1.0 µm					≤ 1.0 µm	≤ 1.0 µm
Cylinder form	≤ 1.5 µm					≤ 1.5 µm	≤ 1.0 µm
Parallelism	≤ 1.5 µm					≤ 1.5 µm	–
<b>Measuring accuracy</b>							
Roundness	≤ 1.0 µm					≤ 2.0 µm	≤ 1.0 µm
Cylinder form	≤ 1.5 µm					≤ 2.0 µm	≤ 1.5 µm
Parallelism	≤ 1.5 µm					≤ 2.0 µm	–
Temperature range of use <sup>2)</sup>	20 – 40 °C					20 – 40 °C	20 – 40 °C
<b>Power supply</b>							
	230 V/50 Hz					230 V/50 Hz	230 V/50 Hz
	115 V/60 Hz					115 V/60 Hz	115 V/60 Hz
Power consumption	150 W					150 W	150 W
Weight of the sensor	2.9 kg					1.9 kg	8 kg <sup>3)</sup>

<sup>1)</sup> Further diameters on demand

<sup>2)</sup> Measuring of the warm distortion on demand (up to 130°C)

<sup>3)</sup> Cylinder bores diameter 60– 80 mm / 80– 110 mm

Product range for Incometer	Ø min/max	Height / depth	Width of part	Laboratory	Production
Cylinder bore	39 – 155 mm	≤ 200 mm	≤ 200 mm	Incometer VS Incometer V	Incometer P
Cylinder liners	39 – 155 mm	≤ 200 mm	≤ 200 mm	Incometer VS Incometer V	Incometer P

# Permanent measurement accuracy

## DAkKS-DKD calibration laboratory

Continuous monitoring of optimum measurement accuracy is necessary to ensure perfect functioning of the measuring instruments. This is because changes in function can occur over the course of normal use, especially due to wear and tear, and these types of changes can go unnoticed. We calibrate the standards you send us in our ISO/IEC 17025 accredited DAkKS-DKD calibration laboratory. This ensures direct tracing of the gaging components to the Federal Physical-Technical Institute (PTB) and guarantees measurements and calibrations at the highest technical standard for measuring.

If a standard cannot be calibrated, a new one can be obtained directly from any of our manufacturing facilities. Simple factory calibration certificates and test reports for non-accredited parameters are also available. We also carry out capability tests for demanding measurement tasks.

## Our range of calibration services

Our DAkKS-DKD accreditation includes the measurement of variables such as roughness, profile depth, roundness, straightness, and parallelism as well as contour standards and roughness measurement instruments. Within this scope we offer DAkKS-DKD calibration certificates:

- for form standards
- for cam shaft standards
- for contour standards
- for roughness standards

## DAkKS-DKD calibration certificate for form standards

Calibration is carried out on our DAkKS-DKD measuring station in an air-conditioned, vibration-insulated measuring room. All common form characteristic values can be determined.

## Magnification standard FN101

For inspecting the amplification of the probing system.  
With test report Art. 521 809  
With DAkKS-DKD calibration certificate Art. 532 528



## Roundness standard FN111

Made of ceramic. For inspecting the radial roundness deviation of the rotational axis.  
With test report Art. 521 799  
With DAkKS-DKD calibration certificate Art. 532 529



## Roughness standard RNDX2 with standard holder FNR

Standard made of nickel with an extra hard protective coating and triangular/sinusoidal grooves. For inspecting the roughness measurement of the Z and R axis.  
Delivered with test report and standard holder FNR for one or two geometry standards of the RNDH or RNDX type.  
Ra: approx. 1.0 µm;  
Rz: approx. 3.3 µm  
Art. 1003 4205



## Set of twist standards

For inspecting the accuracy of the measuring systems.  
Calibrated parameters:  
Dt, DP, DG and Dy.  
Delivered with test report.  
Art. 1001 6265





# Industrial Metrology for your applications

Our range of products and services offers solutions for the most demanding measuring tasks: we can work with you to determine the ideal measuring strategy and configure the appropriate system to meet even your most stringent requirements. In doing so, we take all the important considerations into account, such as the required level of automation, or the ability to integrate the measuring process into the production chain.



## Waveline – Roughness and Contour Metrology

Mobile, manual and automated measuring instruments for determining roughness, contour, topography and twist; combined systems for roughness and contour measurements; optical surface inspection for cylinder bores and customized solutions.



## Formline – Form Metrology

CNC-controlled systems for measuring form, position and twist, combined form and roughness instrumentation, form measurement systems for cylinder bores, crank shaft and cam shaft measuring machines and workpiece-specific solutions.



## Opticline – Optical Shaft Metrology

Optical measuring systems for determining dimensions, form, position and geometric elements on concentric workpieces. Can be used offline, or as an automated SPC measuring station within the production chain and as a customized solution for workpiece-specific requirements.



## Visionline – Optical surface inspection & profile measurement

Systems for automatic, optical surface inspection of inner and outer surfaces, optical measuring systems for determining structural elements in cylinder bores, as well as innovative multi-sensor systems for inspecting components in their entirety.



## Movoline – In-Process Metrology

Digital measuring heads, control devices and accessories for tactile in-process measurements of diameter, position and length in machine tools, all aimed at controlling the machining process of machine tools.



## Gageline – Dimensional Metrology

Pre-, in- and post-process measuring systems for measuring dimensions via tactile or pneumatic technologies, including manual, semi and fully automatic systems, final inspection machines as well as individual in-line systems.



## Serviceline – Services Worldwide

Metrological services that help our customers use their measuring systems to optimum effect, ensure the availability of these systems and maximize their performance.

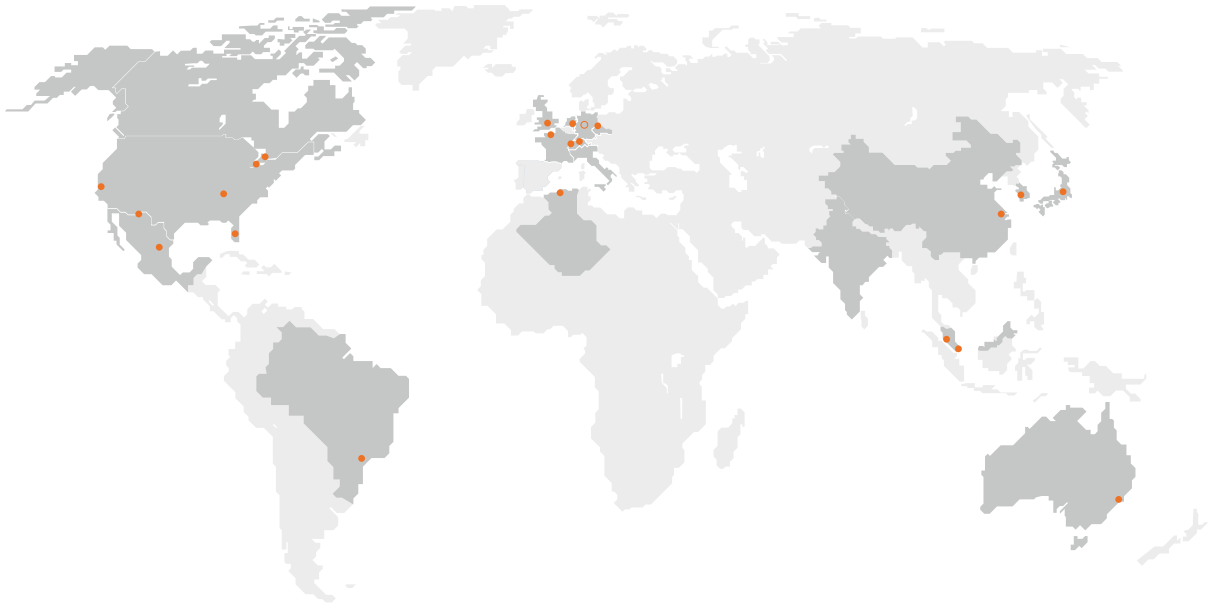

JENOPTIK Industrial Metrology Germany GmbH | Alte Tuttlinger Strasse 20 | 78056 Villingen-Schwenningen | Germany  
Phone +49 7720 602-0 | Fax +49 7720 602-444 | metrology@jenoptik.com | www.jenoptik.com/metrology

